



Dedication to Quality

Fitness Quest warrants this product to be free from all defects in material and workmanship when used according to the manufacturer's instructions. See Limited Warranty Card for details.

If you have any comments or questions contact our Customer Service Department, toll free at 1-800-321-9236, Monday through Friday, 9:00 am to 5:00 pm, EST.

Please record the following information and keep for reference.

Serial #: _____
Date Of Purchase: _____

Save your sales receipt.
(You may wish to staple it into this manual.)



GAZELLE™

SUPRA PRO

OWNER'S MANUAL

**FOR MAXIMUM EFFECTIVENESS
AND SAFETY, PLEASE READ THIS
OWNER'S MANUAL AND VIEW
THE VIDEO BEFORE USING
YOUR GAZELLE™ SUPRA PRO.**

TABLE OF CONTENTS

Important Safety Tips.....	2
Important Safety Warnings.....	3
Specifications & Parts.....	4
Introduction.....	5
Exercise Guidelines.....	6
Warm Up and Cool Down Stretches	8
Target Heart Rate Zone	10
Getting Started	11
Workout Guidelines	12
Gazelle™ Supra Pro Exercises.....	14
Care & Storage	16
Your Total Fitness Program	18
Workout Progress Chart	19
Exercise Data Chart.....	20



©2004 and ©2005 Fitness Quest® Inc. All rights reserved.

Gazelle™ Supra Pro is a trademark of Fitness Quest® Inc. Made in China.

U.S. Patents #5,795,268, #5,857,940 and #D403,033.

No part of this booklet may be reproduced or utilized in any form or by any means electronic, mechanical or otherwise without the expressed written consent of the copyright holder.

IMPORTANT SAFETY TIPS

BEFORE STARTING THIS OR ANY OTHER EXERCISE PROGRAM, CONSULT YOUR PHYSICIAN, who can assist you in determining the target heart rate zone appropriate for your age and physical condition. Certain exercises, programs or types of equipment may not be appropriate for all people. This is especially important for persons over the age of 35, pregnant women, or those with pre-existing health problems or balance impairments.

START OUT SLOWLY AND PROGRESS SENSIBLY. Progress at a pace that is comfortable for you. Perform all of the exercises at the tempo demonstrated in the video for best results.

MONITOR YOUR HEART RATE WHILE YOU EXERCISE AND KEEP YOUR ESTIMATED PULSE RATE WITHIN YOUR TARGET HEART RATE ZONE.

Follow the instructions on page 10 in this manual regarding heart rate monitoring and determining your appropriate target heart rate zone. When used properly, the thumb pulse sensors and display monitor provide a reasonably accurate estimate of your actual heart rate. This estimate is not exact and persons with medical conditions and/or a specific need for accurate heart rate monitoring should not rely on the estimations provided.

DO NOT OVER EXERT YOURSELF WITH THIS OR ANY OTHER EXERCISE PROGRAM.

Listen to your body and respond to any reactions you may be having. You must distinguish “good” pain, like fatigue, from “bad” pain, which hurts. If you experience any pain or tightness in your chest, an irregular heartbeat or shortness of breath, stop exercising immediately. Consult your physician before continuing.

USE CARE WHEN STEPPING ON AND OFF EQUIPMENT. Set up and use your unit on a solid, level, carpeted surface. Follow the instructions demonstrated in your video and on page 11 in this manual for proper entry and exit techniques.

HAVE PLENTY OF CLEARANCE BEHIND AND IN FRONT OF YOUR UNIT. It is important to keep children, pets, furniture and other objects out of the way of the swinging foot platforms. You should have a minimum of 3 feet of clearance both in front of and behind your unit.

WEAR APPROPRIATE CLOTHING WHEN EXERCISING. Workout clothing should be comfortable and lightweight. Wear athletic shoes, such as running or aerobic shoes. Do not use this product with bare feet.

THE UNIT IS NOT INTENDED FOR USE BY CHILDREN. Keep this and all fitness equipment out of the reach of children.

**REMEMBER - REVIEW THIS OWNER'S MANUAL
AND THE VIDEO THOROUGHLY BEFORE
STARTING YOUR WORKOUT!**

IMPORTANT SAFETY WARNINGS

IMPORTANT: SEE PAGE 4 FOR PLACEMENT OF THE FOLLOWING WARNING LABELS ON UNIT.

WARNING LABEL 1

⚠ WARNING

FAILURE TO READ AND FOLLOW THE SAFETY INSTRUCTIONS STATED IN THE OWNER'S MANUAL AND VIDEO MAY RESULT IN POSSIBLE SERIOUS INJURY OR DEATH. KEEP CHILDREN AWAY. MAXIMUM USER WEIGHT 325 LBS. REPLACE LABEL IF DAMAGED, ILLEGIBLE OR REMOVED.

WARNING LABEL 2 (2 LOCATIONS)

⚠ WARNING

CYLINDERS GET VERY HOT DURING USE. DO NOT TOUCH AND PLEASE KEEP CHILDREN AWAY.

WARNING LABEL 3 (2 LOCATIONS)

⚠ WARNING

DISCONNECT HYDRAULIC CYLINDERS BEFORE FOLDING.

SPECIFICATIONS & PARTS

Specifications:

Approximate

Product Weight: Approx. 62 lbs.

Maximum user weight: 325 lbs.

Length: 42-1/2"

Width: 30"

Height: 54"

ALSO INCLUDES:

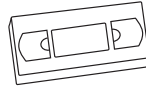

Gazelle™ Supra Pro Total Body Workout Video

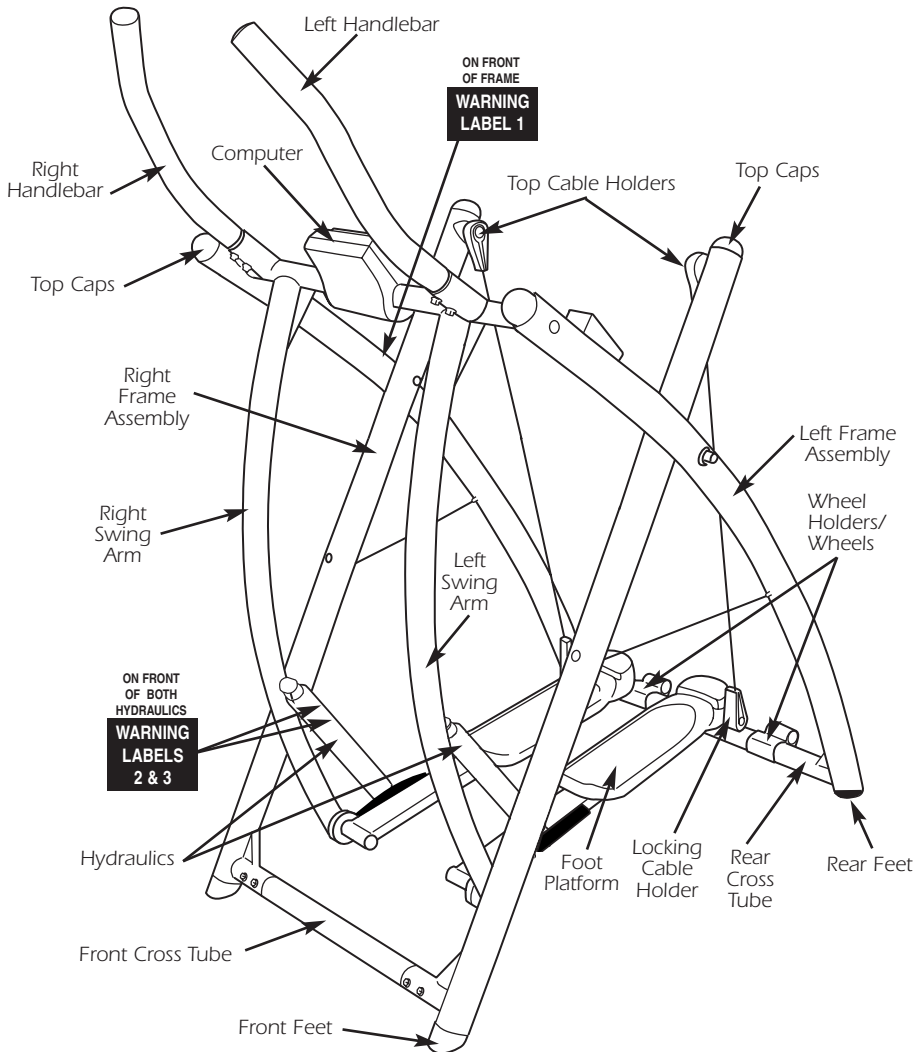

INTRODUCTION

Congratulations on your purchase of the Gazelle™ Supra Pro! You've just taken an important step toward achieving your fitness goals. Whether that means strengthening your heart and lungs, toning muscles, or a combination of these, the Gazelle™ Supra Pro along with the workout video will help you achieve those goals.

Working out on comfortable, efficient equipment that allows you to start and progress at the level that's appropriate for you is a vital element in sticking with a program of regular exercise. With your Gazelle, you'll use the muscles of both your upper and lower body in a pleasant, easy gliding motion to burn calories, firm muscles, and improve your cardiovascular endurance. All of the exercises are easy to do and should feel good, not painful or exhausting. You'll be able to step onto your unit and begin your workout – just what you need to improve your fitness the healthy, easy way!

One hour a week – three fun 20 minute sessions – is all it takes to begin experiencing the health benefits of aerobic exercise. With regular use of your Gazelle, you may soon notice some important changes in yourself, such as:

- More endurance and stamina
- Less body fat and excess weight (if you also follow our eating plan)
- Improved muscle tone in both upper and lower body
- Increased energy for daily tasks
- Less stress and a more positive outlook

And if you increase your exercise program to just 20 minutes **each day**, you can accelerate these benefits dramatically. An impressive return on your investment! Many studies show that a combination of low fat, sensible meals and exercise is the optimum weight loss plan.

We're so sure that you will be completely satisfied with your Gazelle™ Supra Pro, that we encourage you to write us with your comments and suggestions. If, during the course of using your system, you have any questions about the program, please write or call our Customer Service Specialists at the address or phone number listed below, or contact us on our website. As always, you have our quality assurance that we want only your complete satisfaction. After all, your success is our success too!

Sincerely,



Karla Williamson, Customer Service

Gazelle™ Supra Pro, Customer Service Department
244 Fitness Quest Plaza, Canton, OH 44750-1001

1-800-321-9236, Monday through Friday, 9:00 am to 5:00 pm, EST
www.fitnessquest.com

IMPORTANT: This owner's manual is the authoritative source of information about your Gazelle™ Supra Pro. Please read it carefully and follow all the instructions.

EXERCISE GUIDELINES

If you are just starting an exercise program, choose a time of day that's good for you and then stick closely to it. Try to do your workout three times per week at first, and then gradually progress to four or five days a week. Choose a time when you feel energetic, when there are few interruptions, and when you have not eaten a heavy meal for approximately two hours.

Place your unit so that you can easily see your television/VCR. It is important to follow the video workout until you are familiar and comfortable with the exercises. After a few weeks you may prefer to exercise without your video, or extend the duration of your workout. Many people enjoy working out to music of their own choice. Have fun!

MOTIVATIONAL TIPS:

Keep your motivation and interest high by remembering these simple tips:

- **Set Goals For Yourself** that are challenging but realistic. Remember, it may take a few weeks to be able to complete the entire workout easily, or to see changes in your weight or fitness level. Just five minutes of exercise, done several times per day, can change your health. Break your overall goals down into small, measurable steps.
- **Record Your Progress** by using the charts provided at the end of this booklet.
- **Celebrate Your Successes** – even the small ones! Give yourself incentives for reaching each of your goals, and reward yourself often.
- **Take Setbacks In Stride.** If you miss a day on your schedule (or even a week), it's not too late to get back on track. If you are having trouble sticking to your goals, review them and make sure they are realistic. Make adjustments as you think they are needed.

YOUR WORKOUT WILL CONSIST OF THREE PHASES:

Warm-Up

To prevent injury and maximize performance, we recommend that you begin each workout with at least 5 to 10 minutes of exercise that gradually increases your heart rate and warms up your muscles. You can do this by practicing all of the basic movements at a slow tempo and easy range of motion. This type of warm-up is demonstrated in your video.

Stretching exercises are always an important part of any exercise program. We suggest that you do stretching exercises for your calves, hamstrings, hip flexors, triceps, shoulders, quads and back.

Aerobic and Muscle Toning Workout

To gain the health and fitness benefits that you seek, the warm-up should be followed by 15 to 20 minutes of gliding exercises. Build up to this amount as your current fitness level allows, and progress at a rate that is comfortable to you. As your fitness level increases you may want to gradually increase the length of your workouts to a total of 30 minutes per day. Start with 2 or 3 workouts per week. If losing weight is one of your goals, you may want to gradually increase your workouts to 5 or 6 days per week. More frequent workouts and longer durations require the body to burn more calories and use stored fat for energy.

Once the basic workout is comfortable for you, **interval training** offers the opportunity for greater workout variety, cardiovascular benefits and increased calorie burning.

Interval training means alternating short periods of higher intensity

gliding (the “power glides” demonstrated in your video), with periods of lower intensity gliding. When you perform the high intensity exercises, you will work at a level that is at the high end of your Target Heart Rate Zone. The lower intensity exercises are at the low end of your Target Heart Rate.

Monitor your estimated heart rate throughout your workout. It can help you determine the level of exertion that may be most appropriate for you, and serve as a good measure of your progress toward improved fitness.

Beginners can use interval training to simply alternate periods of moderate gliding with rest periods of easy gliding. If you are having difficulty completing 20 minutes of non-stop gliding, work for 3 or 4 minutes then rest with a very small glide for 1 minute. Repeat this until your 15 - 20 minutes are complete.

For an interactive workout, use the Workout Video that comes with your unit.

There are four variables that will help you control the intensity of your workout and keep your heart rate at a safe and appropriate level:

- **The range of motion of your legs and arms.** A wider glide will be higher intensity than a small or narrow glide. Gliding with your knees in a neutral or straight position is easier than gliding with your knees bent in a low position.
- **Your hand position.** A high or low hand grip will allow your arms or legs to alternately work harder. A neutral or middle hand grip will be easier than a high grip because the legs and arms will share the workload evenly.
- **The speed at which you glide.** As you glide at faster tempos your effort will increase. Slowing down the tempo at any time will make your workout easier.
- **The level of resistance.** The position level on the hydraulics can be changed to increase the resistance and make your workout harder.

Cool Down

Towards the end of the aerobic and muscle toning phase of your workout, return to a basic glide movement and gradually slow down the range of motion and tempo. Step off your unit and complete your workout with some gentle stretches as demonstrated in your video. This allows your heart rate to drop gradually back toward its normal resting rate.

WARM UP & COOL DOWN STRETCHES

Stretches can help improve flexibility and relieve the tightness in muscles that results from repetitive sport movements, 10 to 12 minutes of daily stretching is recommended. This should be done when warming up and cooling down. When performing these stretches, your movements should be slow and smooth, with no bouncing or jerking. Move into the stretch until you feel a slight tension, not pain, in the muscle and hold the stretch for 20 to 30 seconds. Breathe slowly and rhythmically. Be sure not to hold your breath. Remember that all stretches must be done for both sides of your body.

1. Quadriceps Stretch

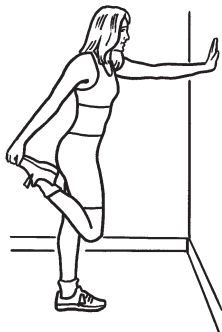

Stand close to a wall, chair or other solid object. Use one hand to assist your balance. Bend the opposite knee and lift your heel towards your buttocks. Reach back and grasp the top of your foot with the same side hand. Keeping your inner thighs close together, slowly pull your foot towards your buttocks until you feel a gentle stretch in the front of your thigh. You do not have to touch your buttocks with your heel. Stop pulling when you feel the stretch. Keep your kneecap pointing straight down and keep your knees close together. **(Do not let the lifted knee swing outward.)** Hold the stretch for 20 to 30 seconds. Repeat for the other leg.

2. Calf and Achilles Stretch

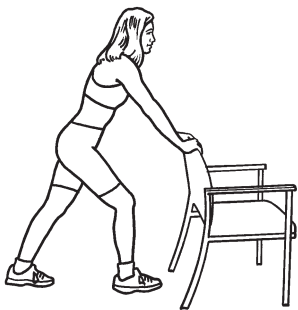

Stand approximately one arms length away from a wall or chair with your feet hip-width apart. Keeping your toes pointed forward, move one leg in close to the chair while extending the other leg behind you. Bending the leg closest to the chair and keeping the other leg straight, place your hands on the chair. Keep the heel of the back leg on the ground and move your hips forward. Slowly lean forward from the ankle, keeping your back leg straight until you feel a stretch in your calf muscles. Hold for 20 to 30 seconds. Repeat for the opposite leg.



3. Overhead/Triceps Stretch

Stand with your feet shoulder width apart and your knees slightly bent. Lift one arm overhead and bend your elbow, reaching down behind your head with your hand toward the opposite shoulder blade. Walk your fingertips down your back as far as you can. Hold this position. Reach up with your opposite hand and grasp your flexed elbow. Gently assist the stretch by pulling on the elbow. Hold for 20 to 30 seconds. Repeat for the opposite arm.



4. Standing Hamstrings Stretch

Stand with your legs hip width apart. Extend one leg out in front of you and keep that foot flat against the ground. With your hands resting lightly on your thighs, bend your back leg and lean forward slightly from your hips until you feel a stretch in the back of your thigh. Be sure to lean forward from the hip joint rather than bending at your waist. Hold for 20 to 30 seconds. Repeat for the opposite leg.

5. Buttocks, Hips and Abdominal Stretch

Lay flat on your back with your hips relaxed against the floor. Bend one leg at the knee. Keeping both shoulders flat on the floor, gently grasp the bent knee with your hands and pull it over your body and towards the ground. You should feel a stretch in your hips, abdominals and lower back. Hold for 20 to 30 seconds and release. Repeat for opposite side.



6. Inner Thigh Stretch

Sit on the floor and bend your legs so that the soles of your feet are together. Place your hands on your ankles. Lean forward from the waist and press down lightly on the inside of your knees. You should feel a stretch in the muscles of your inside thigh.



7. Arm Pullback

Stand with your feet shoulder width apart and toes pointing forward and with your knees slightly bent. Let your arms hang relaxed on either side of your body. Expand your chest and pull your shoulders back. Bend your elbows slightly and clasp your hands behind your back. Slowly straighten your arms as you lift your hands upward. Raise your hands upward until you feel mild tension in your shoulder and chest region. Hold for 20 to 30 seconds. Lower your arms to their original position and bend your elbows. Release your hands and return them to your sides.



TARGET HEART RATE ZONE

BEFORE STARTING THIS OR ANY OTHER EXERCISE PROGRAM, CONSULT YOUR PHYSICIAN, who can assist you in determining the target heart rate zone appropriate for your age and physical condition. Certain exercises, programs or types of equipment may not be appropriate for all people. This is especially important for persons over the age of 35, pregnant women, or those with pre-existing health problems or balance impairments.

MONITOR YOUR HEART RATE WHILE YOU EXERCISE AND KEEP YOUR ESTIMATED PULSE RATE WITHIN YOUR TARGET HEART RATE ZONE. Follow the instructions below regarding heart rate monitoring and determining your appropriate target heart rate zone. When used properly, the heart rate pulse sensors and display monitor provide a reasonably accurate estimate of your actual heart rate. This estimate is not exact and persons with medical conditions and/or a specific need for accurate heart rate monitoring, should not rely on the estimations provided.

Age	Minimum (50%)	Maximum (80%)
20	100	160
22	99	158
24	98	157
26	97	155
28	96	154
30	95	152
32	94	150
34	93	149
36	92	147
38	91	146
40	90	144
45	87	140
50	85	136
55	83	132
60	80	128
65+	77	124

(Age adjusted heart rate (in beats per minute).

Effective aerobic training to improve your fitness and health requires working out at an exercise intensity that raises your pulse to a level that safely challenges your heart and lungs. This level can range between 50% - 80% of your maximum heart rate and is called your **Target Heart Rate Zone**. If you are new to exercise or out of shape, 50% - 60% may be adequate to promote good cardiovascular conditioning. A well conditioned athlete may prefer to work up to an 80% - 85% rate.

Using your estimated heart rate as an indicator of your fitness level provides a built-in work intensifier. If you're untrained, you'll require less effort to reach your target heart rate zone. As your cardiovascular fitness improves and you become stronger, it will require more effort for you to reach your target heart rate zone.

The chart illustrates the predicted minimum and maximum target heart rate zones for cardiovascular fitness for the average individual in good health. To use the chart, find your age and the corresponding minimum and maximum target heart rate zones.

DETERMINING YOUR ESTIMATED HEART RATE

When used properly, the unit pulse sensors can help you to determine your estimated heart rate. To do so:



Pause just long enough from your exercise to take your pulse.

a) Place right thumb on pulse sensor on top of the computer. Wait 6 seconds.

b) Your estimated heart rate range will be displayed on screen. Check the chart above to see if you are within your range according to your age.

Remember that target heart rate zones are predictions and based on averages. Regardless of your estimated heart rate readout, you should slow down if you are breathless and cannot carry on a short conversation.

GETTING STARTED

Once your unit is assembled, make sure it is on a solid, level, carpeted surface with plenty of clearance space behind and in front of the swinging foot platforms. Practice getting on and off your unit a few times until you are comfortable with this movement.

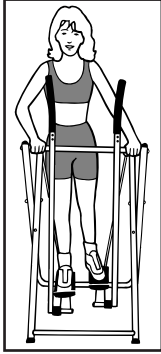
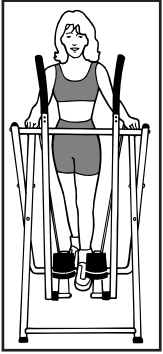

Getting On

Stand behind your unit facing the front crossbar. Place one hand on each back bar and place your left foot centered behind the two foot pedals. Transfer your hands, one at a time, to the front crossbar. Keep your hands on the front crossbar until you are completely on the unit. Carefully place your right foot on the right foot pedal and step on. Next, bring your left foot up to the left foot platform and step on. Keep your hands in place until you feel completely comfortable and balanced. Now you are ready to start gliding.

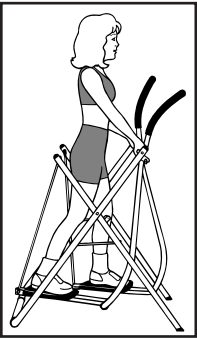

Learning To Glide

Stand upright, with good posture, on the foot platforms. Hold onto the front crossbars with your hands placed just inside the handles. Begin to move your feet back and forth in a very small, controlled glide. When you are comfortable with this leg motion and feel balanced, increase your stride width slightly. Keep your knees "soft" or slightly flexed and your posture upright throughout the motion. This movement is called the "Basic Glide". Use this "Basic Glide" with your hands on the front crossbars to get started, or if you want to decrease your effort at any point during your workout. *Be sure to refer to your video and the exercises explained in this manual before doing any further gliding.*

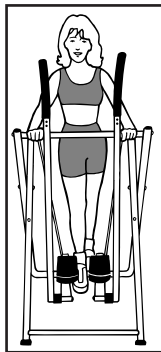
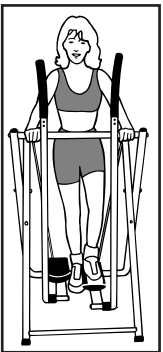

Getting Off

Bring your unit to a complete stop and make sure that you feel balanced on both foot platforms. Place both of your hands on the front crossbar. Keep them in place until you have completely dismounted. Carefully bring your right foot down and place it centered behind the two platforms. Then, carefully bring your left foot down behind the back bar and place it securely on the floor. Let go of the front crossbar, straighten up and lift your right foot out and away from the machine.

WORKOUT GUIDELINES

FOOT PLACEMENT:

You will notice that your feet shift a little bit when using your unit. It is recommended that beginners keep their toes against the toe plate until they feel comfortable with their balance.

HAND POSITIONS:

The position of your hands on the handle grips will allow you to vary the intensity of your workouts and change the emphasis from lower body to upper body. There are five positions that are used throughout your workout.

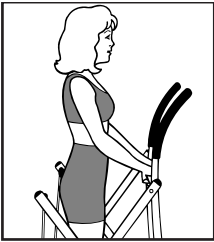

Front Bar Grip

Place your hands on the front crossbar, just to the inside of the handlebars. Use a firm grip without “white knuckles”. Be sure to keep your wrists straight and avoid leaning hard on the arms or bending at your wrists. This grip may be used during any “Basic Glide” exercise. Use this grip when learning to glide, or during your warm-up and cool-down.

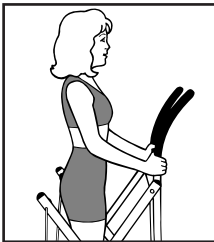

Low Grip

Place your hands at the bottom of the handlebars. Be sure to keep your hands on the black handle grip, not on the front crossbar. This grip will decrease the work in your upper body.

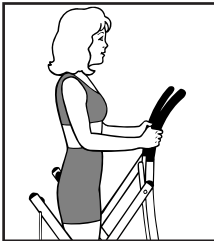

Neutral Grip

Place your hands midway between the bottom and top of the handlebars. Use a firm grip, but try to avoid “white knuckles.” This grip will help you attain equal work for both the upper and lower body.

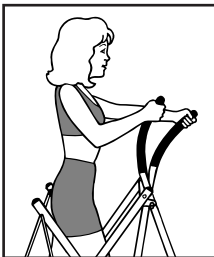

High Grip

Place your hands at the top of the handlebars. Use a firm grip, but try to avoid “white knuckles.” This grip will increase the work in your upper body.

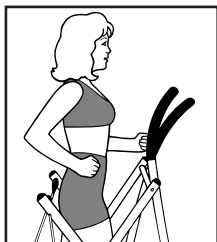

Hands Free (Advanced Position)

Stand in an upright position on the foot platforms with your hands on the front crossbar. When you feel balanced, release your hands from the crossbar and bring them into a bent elbow position at your sides as if you were running or power walking. Practice this position with your feet stationary, then progress to a "Basic Glide".

Note: Exercising without holding onto the handlebars poses a risk of losing your balance and falling, resulting in possible serious injury, should be done with care.

RESISTANCE LEVELS

There are 4 levels of resistance on the unit. Begin exercising at Level 1 (zero resistance) and slowly advance to the next level only when the current level becomes too easy.

Note: The levels increase as you move the Pin towards you to the next position, see Figure 1.

If you do not wish to use the Hydraulics, zero resistance, remove the Clip and move the Hydraulic Pin into Level 1. Replace both Clips, see Figure 1.

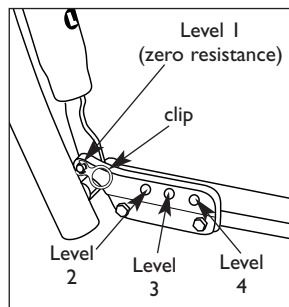

Figure 1: Resistance Levels

GENERAL WORKOUT RECOMMENDATIONS

On the following pages are eight basic exercises that will comprise your basic workout. Before performing any of the exercises, first read through these instructions and refer to your video for correct exercise execution. You can also refer to the videos for variations of these eight exercises and for additional exercises

When you are ready to begin your workout, be sure your equipment is set up correctly and you've warmed up adequately. Then begin with the first exercise and continue through all of the exercises in one continuous cycle, unless you need to take a break. We recommend that you perform 20 - 40 gliding repetitions of each exercise. A single repetition is counted when both legs have glided forward and back (R + L = 1 repetition). Take time to cool down and stretch at the end of your workout.

Remember, you will notice that your feet shift a little bit when using your unit. It is recommended that beginners keep their toes against the toe plate until they feel comfortable with their balance.

Be sure to drink plenty of water before, during and after your workout.

THE GAZELLE™ SUPRA PRO EXERCISES

Please note that additional exercises are shown on your workout video.

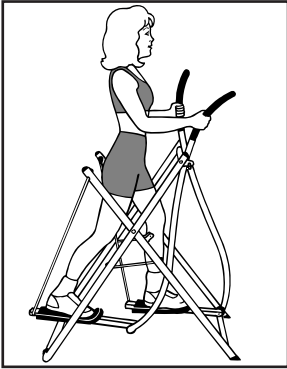

1) BASIC GLIDE

Stand upright on the foot platforms with your hands in the neutral position. Your knees should be “soft,” not locked. Glide your feet back and forth in a controlled manner. The front of each foot platform should glide slightly past the base of the unit frame. Push and pull gently with your arms to assist the leg motion. Maintain good, upright posture throughout this exercise, with your shoulders aligned directly over your hips. This exercise can be performed with the neutral, low or high hand grip positions.

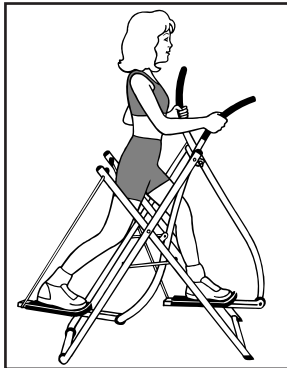

2) WIDE GLIDE

Start with a Basic Glide movement. Gradually increase the length of your stride as far as you comfortably can. Your heels will naturally lift slightly as each leg moves to the back. Do not attempt to keep your heel pressed to the foot platform, but allow this lifting motion to occur. Maintain good, upright posture throughout this exercise, and a “soft” knee position. Glide only as wide as you can while maintaining good balance and posture. This exercise can be performed with the neutral or low hand grip positions.

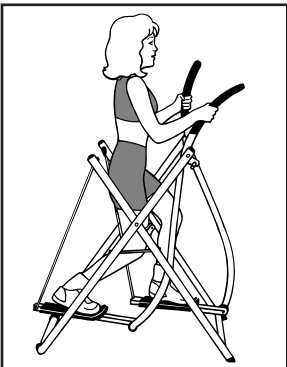

3) LOW GLIDE

Start with a Basic Glide movement. Gradually bend your knees deeper and increase the length of your glide. Let your heels naturally lift as each leg moves to the back. Maintain upright posture throughout this exercise, with your shoulders aligned over your hips. Avoid bending your knees so deeply that they bump against the front swing arms. This exercise can be performed with the neutral or low hand grip positions. You will feel additional emphasis in your thighs during this exercise.

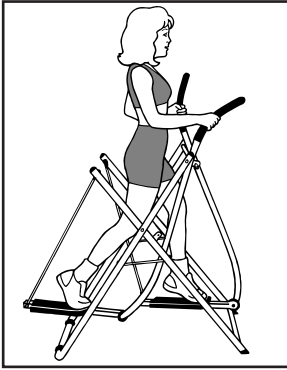

4) HIGH GLIDE

Start with a Basic Glide movement. Lift your heels (rise up on your toes) as you glide, maintaining upright posture. Avoid letting your ankles roll outward as your heels lift. Concentrate on lifting up through the entire body, and pulling your abdominals in to help maintain balance. Your heels should remain lifted throughout the exercise. This exercise can be performed with the neutral or low hand grip positions. You will feel additional emphasis in your calf muscles during this exercise.

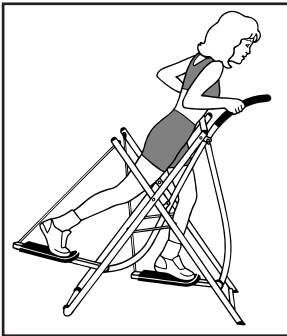

5) FORWARD PUSH (Advanced Exercise)

Begin with a Basic Glide or Wide Glide. Move your hands to a high grip position. As you glide, slowly lean forward until you feel more weight in your arms. Keeping your wrists straight, press forward firmly with alternating arms. Try to fully extend each arm as you push. If you are not able to fully extend each arm, adjust your body position so that you have less forward lean. Make sure you are leaning forward from your ankles, a full body lean, rather than rounding your back. Allow your heels to lift naturally as each leg glides back. This exercise can be performed with the high or neutral hand grip position. You will feel additional emphasis in the

chest, front shoulder, and the back of the upper arm during this exercise. **This is an advanced exercise that should be performed only after proficiency is attained on the first four basic exercises.**

Note: Exercising while leaning forward poses a risk of losing your balance and falling, resulting in possible serious injury, and should be done with care.

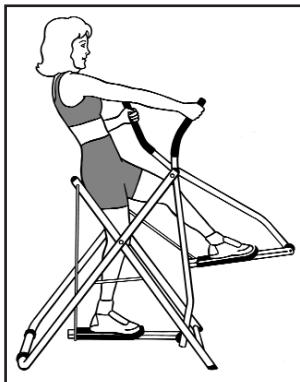

6) BACKWARD LEAN (Advanced Exercise)

Begin with a Basic Glide. Move your hands to a high grip position. As you glide, slowly lean back until you feel more weight in your arms. Your legs will glide in front of your body. Keeping your wrists straight, pull back firmly with alternating arms. Make sure you are leaning back from your ankles, a full body lean, rather than rounding your back or "sitting". This exercise can be performed with the high or neutral hand grip position. You will feel additional emphasis in the upper back, back shoulders, and the biceps during this exercise. **This is an advanced exercise that should be performed only after proficiency is attained on the first four basic exercises.**

Note: Exercising while leaning backward poses a risk of losing your balance and falling, resulting in possible serious injury, and should be done with care.

- If squeaks or other noises develop over time, we recommend the following:
 - a) Lubricate all moving parts. For best results we recommend using white lithium grease. You may also apply clear household grease (i.e. petroleum jelly) to axle tube.
 - b) Spray cable holders (top & bottom) with WD40 or equivalent.
 - c) Check to be sure that the screws on the bottom of the foot platforms are tight.

Storing your Unit

Your unit conveniently folds down for easy storage. **Note: The Gazelle may be heavy and awkward, if you cannot maneuver the unit easily by yourself, we recommend folding the unit with two people.**

To fold the unit:

- a. Disconnect the Right and Left Hydraulic. **IMPORTANT: Disconnecting the Hydraulics must be done prior to folding.**
- b. Fold the Right and Left Foot Platforms up and lock them into place by snapping the Lower Cable Holders onto each Swing Arm as shown.
- c. Stand on either the right or left side and face the unit. Place one foot directly in front of one Front Foot to hold the unit in place.
- d. Grasp top of Right Frame with one hand and top of Left Frame with the other, push frames together.
- e. While holding the unit steady, position yourself behind the unit and carefully lower it towards the ground until both wheels engage. Roll unit away to be stored.

Note: When lowering the unit towards you, take caution as the Hydraulics are disconnected and can swing freely.

Store the Gazelle in an area away from children and high traffic areas.

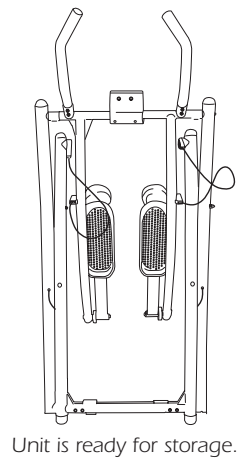
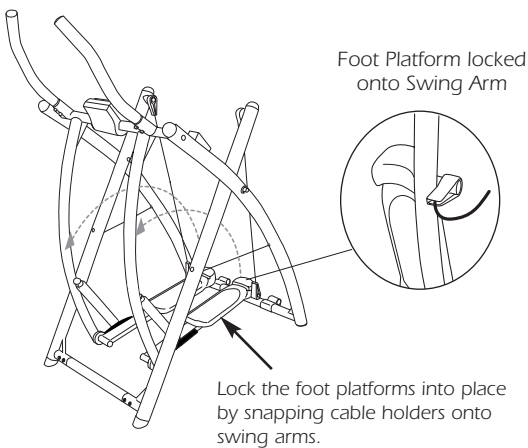

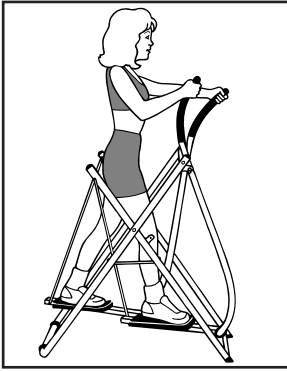

7) POWER GLIDE (Advanced Exercise)

Begin with a Wide Glide. Adjust your hands to a neutral or high grip hand position. Gradually increase the length of your stride as far as you comfortably can. Your heels will naturally lift slightly as each leg moves to the back. As you glide, allow your shoulders and torso to rotate slightly side to side, pressing and pulling firmly with your arms. Maintain good, upright posture throughout this exercise, and a “soft” knee position. Avoid over rotating your torso which could effect balance. This exercise can be performed with the neutral or high hand grip positions. Glide only as wide as you can while maintaining good balance and posture.

The Power Glide is an advanced exercise that should be performed only after proficiency is attained on the first four basic exercises.

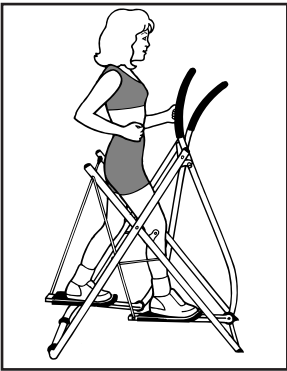

8) POWER JOG (Advanced Exercise)

Begin with a Basic Glide. When you feel comfortable and balanced, slowly release your hands and bring them into your sides in a “jog” position. Allow your arms to pump naturally as if you were jogging. Maintain good, upright posture throughout this exercise, and a “soft” knee position. Glide only as wide as you can while maintaining good balance and posture. Be careful not to get your head or shoulders in the way of the swinging handles. Upright posture will prevent this from happening. **This is an advanced exercise that should be performed only after proficiency is attained on the first four basic exercises.**

Note: Exercising without holding on to the handlebars poses a risk of losing your balance and falling, resulting in possible serious injury, and should be done with care.

CARE & STORAGE

Caring for your Unit

Your unit has been carefully designed to require minimum maintenance. To ensure this, we recommend the following:

- Keep your unit clean by wiping sweat, dust or other residue off with a soft, clean cloth after each use.
- Wipe your handle grips down with a soft, damp cloth frequently to prevent accumulation of sweat and dirt.

YOUR TOTAL FITNESS PROGRAM

A Total Fitness Program is more than exercise and more than eating right. It is a “fitness for life” plan that goes hand in hand with an overall healthy lifestyle. This includes regular check-ups and exercise, now and for the rest of your life.

Your total fitness program consists of three parts:

- Aerobic exercise to burn calories.
- Strength conditioning exercises to tone and shape your muscles, increase your metabolic rate, and strengthen your bones.
- A diet that is safe, sensible and healthy.

Today, all fitness research recommends both aerobic exercise and strength conditioning to achieve balanced fitness. By improving your aerobic fitness you will strengthen your heart and lungs, increase your stamina and endurance, and help with weight loss. Strength conditioning adds lean muscle to your body, increasing your body's metabolism. In this process, your body burns more calories, even while you rest. When you combine aerobic workouts with strength conditioning, as you will with your Gazelle™ Supra Pro, you can burn more fat and calories than with just aerobic exercise alone.

The Gazelle™ Supra Pro workout will help with the first two parts of your Total Fitness Program, but you need to make healthy, low-fat eating a big priority as well.

Consult with your physician about an eating plan that's right for you. Healthy eating habits and exercise will help you reach your goal. We recommend that you follow dietary guidelines approved by the U.S. Department of Agriculture and the U.S. Department of Health and Human Services. These guidelines are contained in the Food Guide Pyramid.

Starting at the base of the pyramid, you should strive for 6 - 11 servings a day from the Bread, Cereal, Rice and Pasta food group. You should eat 3 - 5 servings a day from the Vegetable group, and 2 - 4 servings from the Fruit group. You should also eat 2 - 3 servings a day from the Milk, Yogurt and Cheese group, and from the Meat, Poultry, Fish, Beans, Eggs and Nuts food group. Lastly, use Fats, Oils and Sweets sparingly.

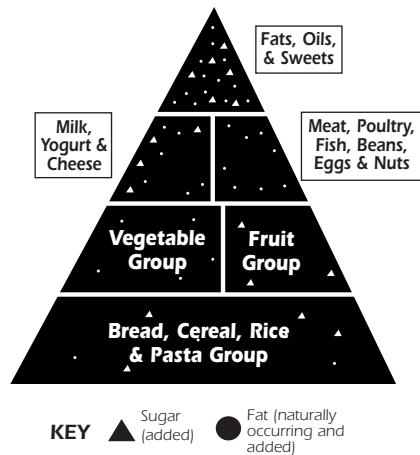

WORKOUT PROGRESS CHART

Use the chart below and the charts on the following pages to keep track of your progress over time. Before writing on them, make as many copies as you think you'll need. We suggest you keep these in a notebook. You will find it both informative and motivational to look back at what you've done, and this data will help you to chart future fitness goals as you progress. Every two weeks, measure yourself to rechart your progress.

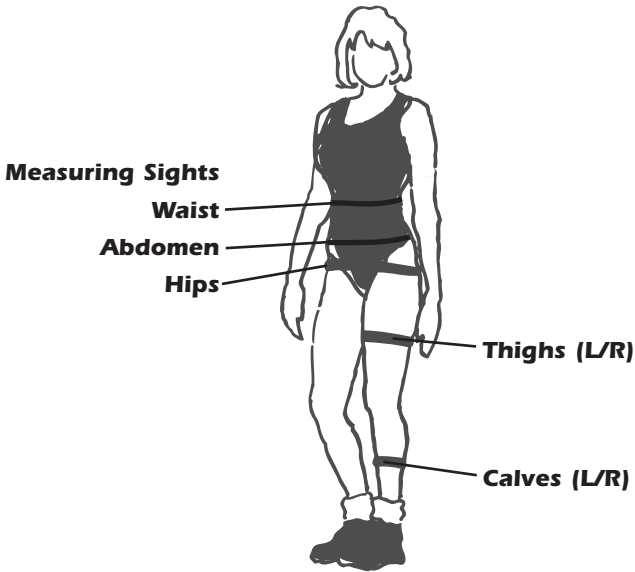

Date	Weight	Waist	Abdomen	Hips	Thighs	Calves	Resting Heart Rate

